

Dot-Less II Luminous

17W/m & 8W/m

With a higher fixture profile of 19mm(W) x 20mm(H), the Dot-Less II is even more seamless compare to Dot-Less 1-2.

The Dot-Less II can achieve uniform effect without LED dots seen and at a much lower cost than Dot-Less 1-2. Making it the ideal choice for application that are very close to reflective surfaces. For semi-custom specifications, a higher-CRI version (Ra98 R9 90 typical) is available.



DC24V

17W/m &
8W/m

Indoor

Ra93 typ
for LUMINOUS Series

Dimmable

FEATURES

- Linear LED fixture with uniform light throughout the whole surface of fixture's diffuser and "LED Spot-Less" (=Dot-Less) feature
- Available in CCT 2500K, 2700K, 3000K, 3500K, 4000K and 1800K, 2000K, 2200K, 4500K
- Most suitable for those applications of indirect lighting which illuminates glossy material like tile, metal, onyx, and so forth.
- Excellent efficiency using NICHIA Japan LED CRI Ra93(typical) 90min



BASIC SPECIFICATION

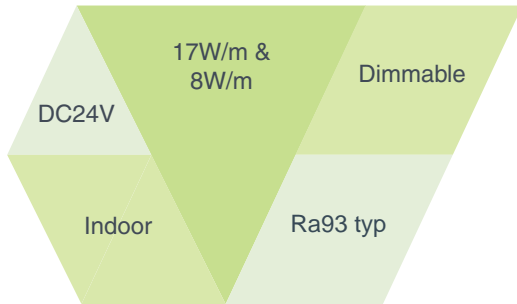

+ As semi-custom spec CRI Ra98 R9 90 available. Refer to the page of product model code reading

MECHANICAL DRAWING

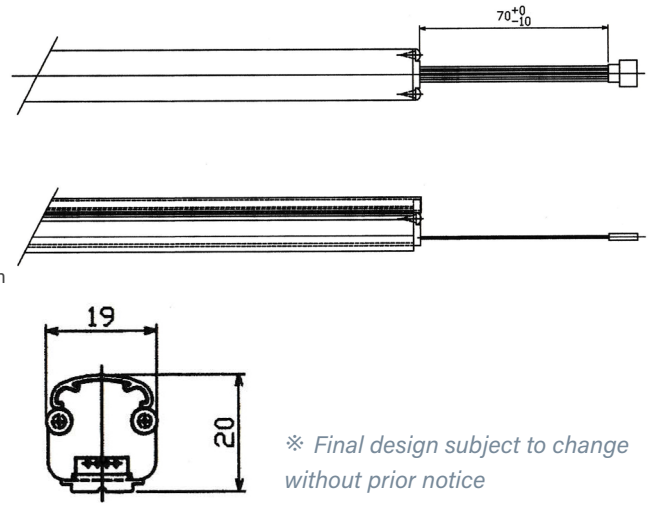

Male-Female Connector

(Standard Spec comes with this connector)

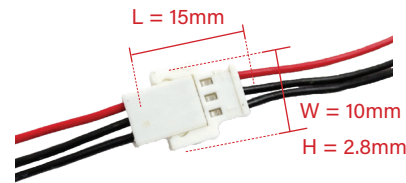

White Cable = Positive (+)

Two Black Cable = Negative (-) (to be joined together)

MODEL NO

Model No

DX

XXXX – XXX

B – XX

Fixture Type

Fixture Length

Color Temperature

Type of LED used

Fixture Type

- DL** → Dot-Less II (17W per meter)
- DE** → Dot-Less II (8W per meter)

Fixture Length (for Dot-Less II)

- 0960** → L960mm, **Standard**
- 0640** → L640mm, **Standard**
- 0320** → L320mm, **Standard**
- 0112** → L112mm, Build-to-order
- 1175** → **L1175mm, Standard**

Other fixture length available: 860mm, 747mm, 215mm

Color Temperature

- 253** → 2500K
- 273** → 2700K
- 303** → 3000K
- 353** → 3500K (Build-to-order)
- 403** → 4000K
- 503** → 5000K (Build-to-order)

Other CCT available: 1800K / 2000K / 2200K / 4500K

Type of LED used

- B** → Type B, manufactured by NICHIA Japan (Ra93 typ.) (= Standard for Dot-Less II)

↓

LS : Luminous Series
(upgraded high-efficiency high CRI 90(min))

OS : NICHIA LED Optisolis CRI 98 R9 90 (typical)

Example

DL

0960 – 3003

B – LS

Fixture Type

Fixture Length

Color Temperature

Type of LED used

LS : Luminous Series

Dot-Less II
(17W per meter)

L960mm, Standard

3000K

Type B,
manufactured by
NICHIA Japan
(Ra95 typ.)

PRODUCT SPECIFICATIONS

Product Name	Dot-Less II Luminous (17.0 W/meter)			Dot-Less II Luminous (8.0 W/meter)		
Model No.	DL0320-XXB-LS (L320mm)	DL0640-XXB-LS (L640mm)	DL0960-XXBLS (L960mm)	DE0320-XXBLS (L320mm)	DE0640-XXB-LS (L640mm)	DE0960-XXB-LS (L960mm)
Input Voltage	24.0Vdc (TDK Lambda recommended)					
Power Consumption	5.5 W (Apprx. 17.0 W/meter)	10.8 W (Apprx. 17.0 W/meter)	16.3 W (Apprx. 17.0 W/meter)	2.7 W	5.4 W	8.0 W
Dimension (mm)	320*19*20(H)	640*19*20(H)	960*19*20(H)	320*19*20(H)	640*19*20(H)	960*19*20(H)
Weight	93 grams	185 grams	277 grams	93 grams	185 grams	277 grams
Casing Body	Aluminium extrusion heatsink with frost polycarbonate cover					
LED Beam Angle	105°	105°	105°	105°	105°	105°
Operating Temperature	-10°C~45°C	-10°C~45°C	-10°C~45°C	-10°C~45°C	-10°C~45°C	-10°C~45°C
Maximum Length of Series Connection	4 meter	4 meter	4 meter	8 meter	8 meter	8 meter
Option Parts	Mounting clip bracket 0° (flat) type / or 45° fixed angle type					
No of LEDs	21	42	63	21	42	63
Power Supply Unit	24.0Vdc Constant-Voltage Switching Power Supply (*TDK Lambda brand recommended)					
Dimming Control	*With recommended 0-10V /or DMX compatible dimming driver unit					
Lumens (typical @ 3000K)	490 Lumens	980 Lumens	1478 Lumens	252 Lumens	503 Lumens	757 Lumens
Available LED Color						
Daylight 6500K (Ra85)	●	●	●	●	●	●
Cool White 4000K (Ra95)	●	●	●	●	●	●
3500K (Ra94)	●	●	●	●	●	●
Light Warm 3000K (Ra95)	●	●	●	●	●	●
Standard Warm 2700K (Ra95)	●	●	●	●	●	●
Dark Warm 2500K (Ra85)	●	●	●	●	●	●
RGB Full Color	NA	NA	NA	NA	NA	NA

* For installation/wiring, refer to page 41.

NOTE: Lumen output for semi-custom CRI Ra98 R9 90 (typical) type is typically 32% lower than LUMINOUS series

OPTIONAL ACCESSORIES

1 Mounting Clip Bracket 0° Flat Type

Model: MC-0DEG

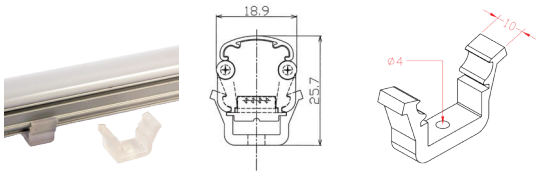

2 Mounting Clip Bracket 45° Type

Model: MC-45DEG

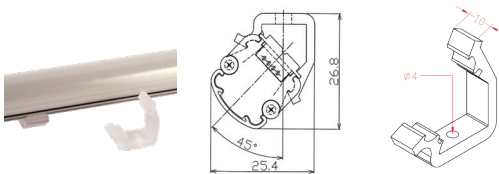

PHOTOMETRICS

Brownie Ecotronics:
Dot-Less II Luminous, 3000K, L960mm, 17.3W

Product Code: DL0960-303B-LS
 Luminous Flux (luminaire): 1478 lm
 Luminous Flux (lamp): 1478 lm
 Luminaire Wattage: 17.3W

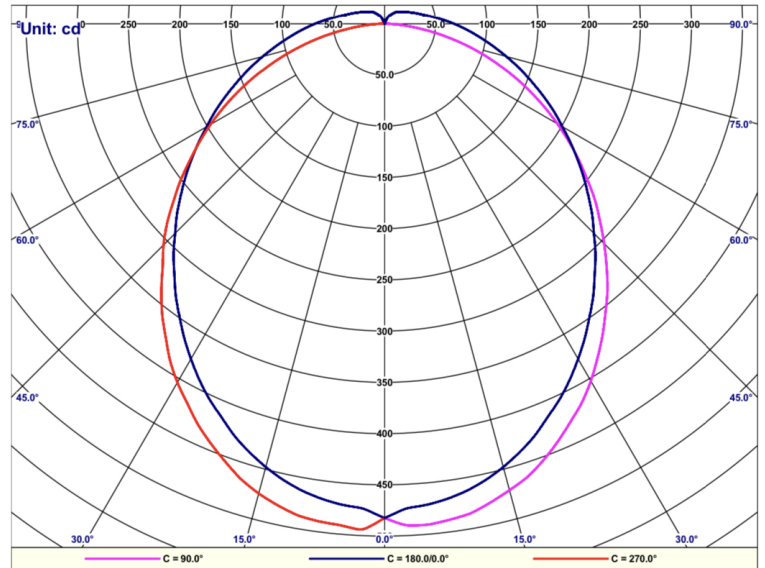

Brownie Ecotronics:
Dot-Less II Luminous 3000K, L960mm, 8.0W

Product Code: DE0960-303B-LS
 Luminous Flux (luminaire): 757 lm

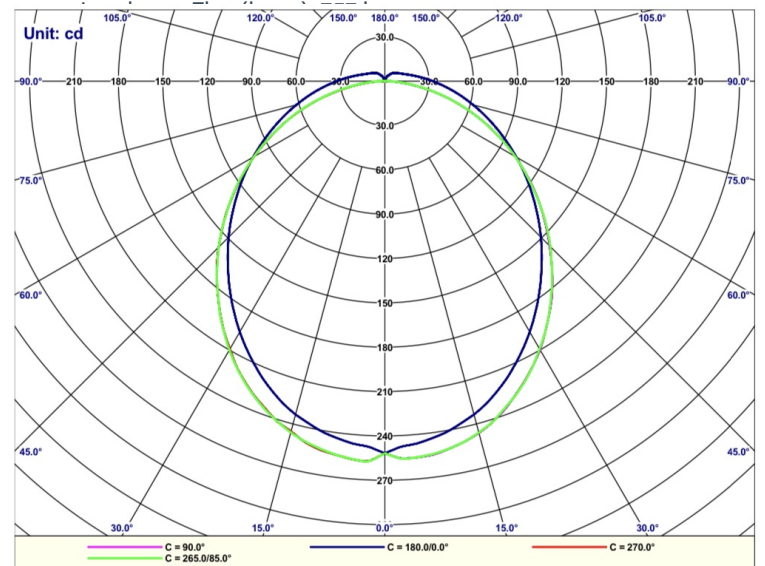

PROJECT REFERENCE

